

ZM205

Baggage Scale Indicators



User Instructions

Avery Weigh-Tronix is a trademark of the Illinois Tool Works group of companies whose ultimate parent company is Illinois Tool Works Inc (“Illinois Tool Works”). Copyright © 2019 Illinois Tool Works. All rights reserved.

No part of this publication may be reproduced by making a facsimile copy, by the making of a copy in three dimensions of a two-dimensional work and the making of a copy in two dimensions of a three-dimensional work, stored in any medium by electronic means, or transmitted in any form or by any means, including electronic, mechanical, broadcasting, recording or otherwise without the prior written consent of the copyright owner, under license, or as permitted by law.

This publication was correct at the time of going to print, however Avery Weigh-Tronix reserves the right to alter without notice the specification, design, price or conditions of supply of any product or service at any time.

Table of Contents

	<i>page</i>
Table of Contents	3
Chapter 1 General information and warnings	5
About this manual	5
Text conventions	5
Special messages	5
Installation	6
Safe handling of equipment with batteries	6
Routine maintenance	6
Cleaning the machine	7
Training	7
Sharp objects	7
Chapter 2 Introduction	8
Front panel	9
Annunciators	10
Powering up the ZM205	10
Numeric entry procedure	11
Chapter 3 Indicator Operation	12
Gross Weighing	12
Accumulator Weighing	12
Chapter 4 Error messages	14
Chapter 5 Menus	15
Accessing the menus	15
Menu annunciators	15
Exiting the menus	16
USER level menus	16
User menu	17
Time	17
Date	18
Site ID	19
Seal	19
About menu	20
Boot	20
Firm and App	21
Serial	21
Option	21
Enet	22
Dload	23
Audit menu	24
Counter	24
Chapter 6 Communications	25
Chapter 7 Supervisor menu	26
Setpoint	27

1 General information and warnings

1.1 About this manual

This manual is divided into chapters by the chapter number and the large text at the top of a page. Subsections are labeled as shown by the 1.1 and 1.1.1 headings. The names of the chapter and the next subsection level appear at the top of alternating pages of the manual to remind you of where you are in the manual. The manual name and page numbers appear at the bottom of the pages.

1.1.1 Text conventions

Key names are shown in **bold** and reflect the case of the key being described. If a key has a dual function it may be referred to by its alternate function.

Displayed messages appear in ***bold italic*** type and reflect the case of the displayed message.

Annunciator names appear as *italic* text.

1.1.2 Special messages

Examples of special messages you will see in this manual are defined below. The signal words have specific meanings to alert you to additional information or the relative level of hazard.



CAUTION!

This is a Caution symbol.

Cautions give information about procedures that, if not observed, could result in damage to equipment or corruption to and loss of data.



NOTE: *This is a Note symbol. Notes give additional and important information, hints and tips that help you to use your product.*



ELECTRICAL WARNING!

THIS IS AN ELECTRICAL WARNING SYMBOL.

ELECTRICAL WARNINGS MEAN THAT FAILURE TO FOLLOW SPECIFIC PRACTICES OR PROCEDURES MAY RESULT IN ELECTROCUTION, ARC BURNS, EXPLOSIONS OR OTHER HAZARDS THAT MAY CAUSE INJURY OR DEATH.

1.2 Installation



NO USER SERVICEABLE PARTS. REFER TO QUALIFIED SERVICE PERSONNEL FOR SERVICE.



Equipment to be powered by a UL Listed I.T.E. power supply: rated 12 -36VDC and marked "LPS", or a UL Listed power supply rated 12-36VDC and marked "Class 2."



The Socket-Outlet shall be installed near the equipment and shall be easily accessible.



2012/19/EU (WEEE directive): Products marked with this symbol cannot be disposed of as unsorted municipal waste in the European Union. For proper recycling, return this product to your local supplier upon the purchase of equivalent new equipment, or dispose of it at designated collection points.

1.2.1 Safe handling of equipment with batteries



CAUTION: Danger of explosion if battery is incorrectly replaced. Replace only with the same or equivalent type recommended by the manufacturer. Dispose of used batteries according to the manufacturer's instructions.

ATTENTION: Il y a danger d'explosion s'il y a remplacement incorrect de la batterie, remplacer uniquement avec une batterie du même type ou d'un type équivalent recommandé par le constructeur. Mettre au rebut les batteries usagées conformément aux instructions du fabricant.

1.3 Routine maintenance



IMPORTANT: This equipment must be routinely checked for proper operation and calibration. Application and usage will determine the frequency of calibration required for safe operation.

Always isolate the indicator from the power supply before starting any routine maintenance to avoid the possibility of electric shock.

1.4 Cleaning the machine

Table 1.1 Cleaning DOs and DON'Ts



DO	DO NOT
Wipe down the outside of standard products with a clean cloth, moistened with water and a small amount of mild detergent	Attempt to clean the inside of the machine
	Use harsh abrasives, solvents, scouring cleaners or alkaline cleaning solutions
Spray the cloth when using a proprietary cleaning fluid	Spray any liquid directly on to the display windows

1.5 Training

Do not attempt to operate or complete any procedure on a machine unless you have received the appropriate training or read the instruction books.

To avoid the risk of RSI (Repetitive Strain Injury), place the machine on a surface which is ergonomically satisfactory to the user. Take frequent breaks during prolonged usage.

1.6 Sharp objects

Do not use sharp objects such as screwdrivers or long fingernails to operate the keys.

2 Introduction

The ZM205 baggage scale indicators consist of a main indicator with six keys and digital display and a keyless remote display. The front panels of both indicators are shown in [Figure 2.1](#). The indicator has two serial COM ports and an Ethernet port.

The indicator also has three logic level inputs with configurable functions and three setpoint outputs. See the Specification literature for a full list of specifications.

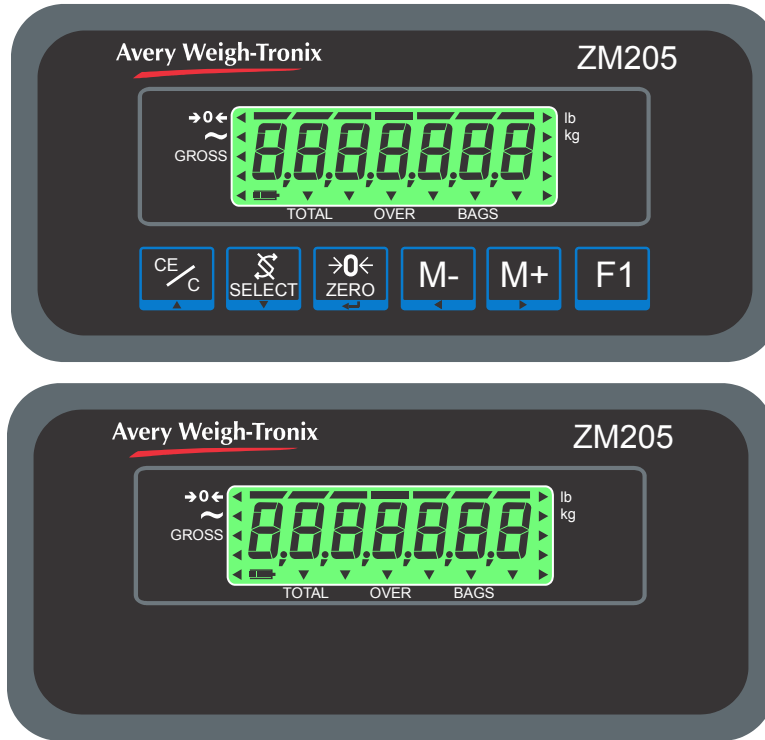
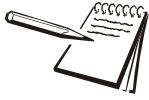

Figure 2.1 Front panels of the ZM205 indicators

The ZM205 can connect to printers, computers and other peripheral devices via ethernet and serial connections.





2.1 Front panel

The front panel, shown in [Figure 2.1](#), consists of the keys and display.



Never press a key with anything but your finger. Damage to the overlay may result if sharp or rough objects are used.

There are six keys on the front panel. Their functions are listed below.

Key	Description
	Press the CE/C key to clear the previous accumulator or hold the key to clear all accumulators. Also acts as an up arrow key when in the User menu.
	Press the SELECT key to scroll through Gross, Gross Total and Transaction Count displays. Also acts as a Down arrow key when in the User menu.
	Press the ZERO key to zero the display. Also acts as an Enter key when in the User menu.
	Press the M- key to subtract the last bag from the total. Also acts as a Left arrow key when in the User menu.
	Press the M+ key to accumulate. Also acts as a Right arrow key in the User menu.
	Press and hold the F1 key to access the User menu.

2.1.1 Annunciators

The annunciators on the display are shown and labeled in [Figure 2.2](#).

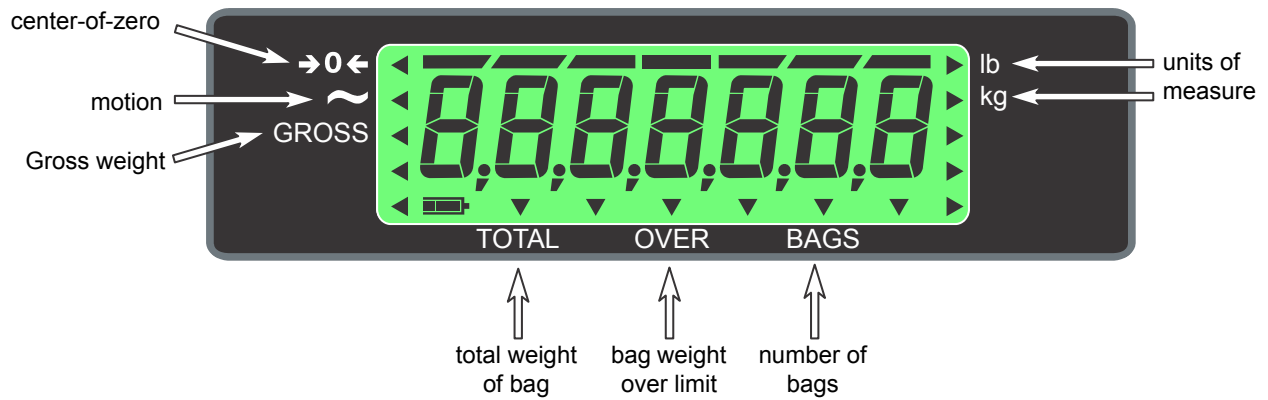

Figure 2.2 Annunciators

2.2 Powering up the ZM205

The indicator is always active as long as power is received. Power can be supplied by an AC to DC power converter - (12 to 36 VDC).

The remote display is powered via the ethernet connection to the main indicator.

2.3 Numeric entry procedure

The keys in [Figure 2.3](#) have alternate functions in numeric entry screens.

	These segments flash in numeric entry mode
CE/C / ▲	– Press to increment the flashing number
SELECT / ▼	– Press to decrement the flashing number
M- / ◀	– Press to backspace cursor in a number
M+ / ▶	– Press to advance cursor in a number
ZERO / ↵	– Press to accept a value
F1 / ESC	– Press to escape an entry screen

Figure 2.3 Key function during numeric entry

In numeric entry screens, the center segments shown in [Figure 2.3](#) flash. Use the keys, as described in [Figure 2.3](#), to enter a value on the display. Following is an example:

Example: To key in the number 507:

Repeatedly press the **CE/C(▲)** or **SELECT(▼)** key until **5** appears on the display.

Press the **M+(→)** key once to move cursor one space to the right.

Repeatedly press the **CE/C(▲)** or **SELECT(▼)** key until **0** appears on the display.

Press the **M+(→)** key once to move cursor one space to the right.

Repeatedly press the **CE/C(▲)** or **SELECT(▼)** key until **7** appears on the display.

Press the **ZERO** key to enter or accept the value.

Press the **M-(←)** key to move the entry function one digit to the left. This effectively deletes the current value in that position and allows you to enter a new value in that position.

3 Indicator Operation

The ZM205 performs weighing and accumulation. Below are instructions for each.

3.1 Gross Weighing

To perform gross weighing, power up the unit and follow these steps:

1. Empty the scale and press **ZERO** key to zero the display ...
0 is displayed and gross and center of zero annunciators are lit.
2. Place the bag to be weighed on the scale ...
Weight is displayed.



The OVER annunciator operation requires setup by a Supervisor.

3.2 Accumulator Weighing

The accumulator is memory that collects individual weighments and stores the totals. These gross weight totals can be recalled at any time and displayed. By holding the **CE/C** key, all information can be cleared.

To use the accumulator, power up the unit and follow these steps:

1. Empty the scale and press **ZERO** key to zero the display ...
0 is displayed and gross and center of zero annunciators are lit.
2. Place a bag on the scale ...
Weight is displayed.
3. You can press the **M+** key to add weight to the accumulator. If you press **M+**, the weight is accumulated and the annunciator shown below lights momentarily.



Scale weight must return to zero before another weighment can be accumulated.

4. Repeat 2 and 3 for each weighment you want to accumulate.
5. To review the accumulator total, press the **SELECT** key once ...

The total of all weighments is displayed for two seconds, then number of bags is displayed for two seconds, then the display returns to gross weigh mode.

6. To clear the accumulator, press and hold the **CE/C** key for three seconds.











Press the **M-** key to remove the last accumulated weight from the total, if necessary. The annunciator shown below lights momentarily when the key is pressed.



The remote or passenger indicator will display the same values shown on the main or operator indicator.

4 Error messages

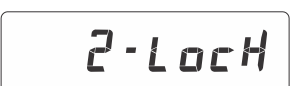
The following error messages may be displayed during use of the indicator:

Message	Display
Overload	
Can't fit on display	
Underload	
Can't	
Entry not in valid range	
Password entry failed	
Remote display not receiving data from the master indicator	
Indicator did not reach a stable zero weight within time window set for automated weighing process.	  

5 Menu

Menus provide a method for auditing the indicator or supervisor configurations.

5.1 Accessing the menus

Follow these steps to access the menus in the ZM205.

1. With the indicator powered up and in normal operating mode, press and hold **F1** ...

Pass is displayed, prompting you to enter the password.

2. Key in the password for the menu you want and press the **ZERO** key ...

The first item in the top level of the menu you accessed is displayed.

3. Use the navigation keys, shown below, to navigate through the menu structure. The symbols in the chart appear on the bottom of the keys.

Press **SELECT/ ▼** to move down in a menu
 Press **CE/C/ ▲** to move up in a menu, except at the bottom item in a menu, then use **ZERO/ ←** or **F1**
 Press **M-/ ◀** to move left in a menu
 Press **M+/ ▶** to move right in a menu
 Press **ZERO/ ↵** to accept a value or choice and move up in the menu.
 Press **F1** to escape and move up in the menu

5.2 Menu annunciators

The menu structure is made up of menu items, parameters, value entry screens and lists from which you choose one item. To help you know where you are in the menu, the bargraph at the top of the display is on while the indicator is in the menus and will change appearance according to the following rules:

All segments flashing	This means you are in the menu structure but not in any of the following screens.
Center flashing / others solid	This means you are in a parameter prompt screen.
Center flashing / others off	This means you are in a numeric entry screen. Enter a number and press ZERO to accept.
Right flashing / others off	This means you are in a list. Scroll through the choices with the M- and M+ keys and press ZERO to accept.

5.3 Exiting the menus

1. If you are at the bottom item in a menu use **ZERO** to accept a choice or value and move up a level, or use **F1** to escape and move up one level without accepting the choice or value. From that point, press **CE/C** repeatedly until ...

SAVE no is displayed. This means “Do not save changes.”

2. Press **M+** to scroll through the choices: **SAVE no**, **SAVEYES** and **CAnCEL**. Press **ZERO** to accept the displayed choice.

If you choose **SAVE no** or **SAVEYES** the indicator exits the menu and returns to normal weighing mode.

OR

If you choose **CAnCEL**, the indicator remains in the menu.

5.4 USER level menus

The USER level menus are available to the user. The other menu levels are for supervisors and technicians only.

The USER level (password 111) contains the User, About, and Audit menus arranged as shown in [Figure 5.1](#).

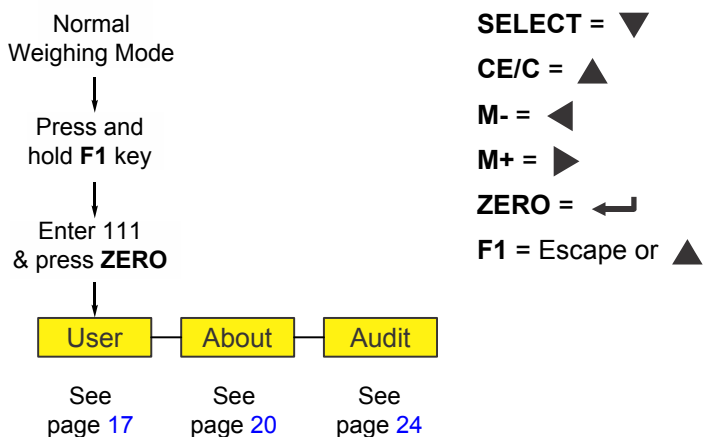

Figure 5.1 USER level (password 111) menus

5.5 User menu

The User menu is shown in [Figure 5.2](#).

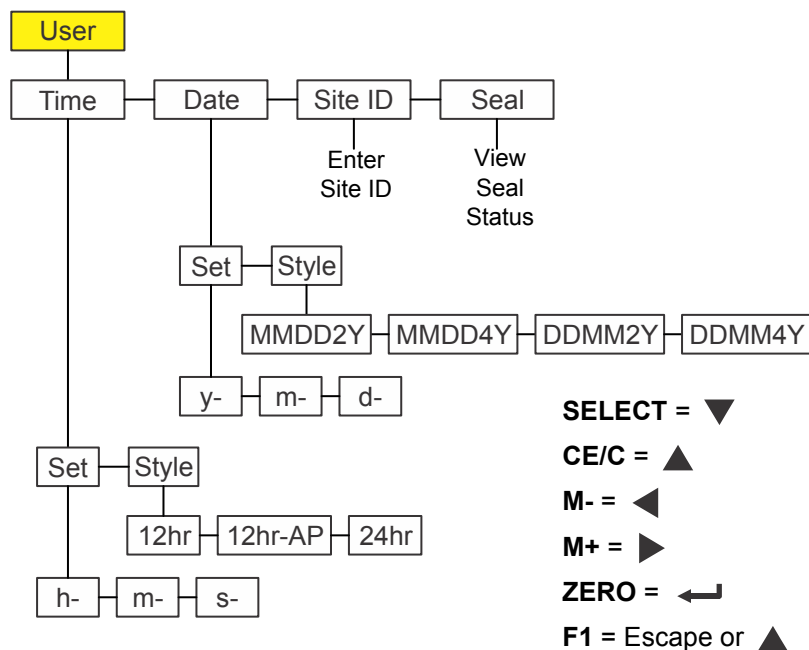

Figure 5.2 User menu

Use this menu to set the time and date, to enter a site ID, and view the physical seal status. Each is explained below. Use the [Numeric entry procedure on page 11](#) when you need to enter values.

5.5.1 Time

User ↓ Time



The ↓ and → symbols used in this section stand for direction moved in the menu. So User ↓ Time, shown above, illustrates that you move down from **uSER** to **tiME**. This will help you keep track of where you are in the menu structure.

1. Access the User menu (see [Accessing the menus on page 15](#)) and press **SELECT** ...
tiME is displayed. Use this to set the time and clock style.
2. Press **SELECT** ...
SEt is displayed.
3. Press **SELECT** ...
h- x is displayed, with the **x** flashing. This is a numeric entry screen for the hour value.

4. Key in the hour of the day using military (24 hr) time and press **ZERO** to accept ...
M- x is displayed, with the **x** flashing. This is a numeric entry screen for the minute value.
5. Key in the minute value and press **ZERO** to accept ...
S- x is displayed, with the **x** flashing. This is a numeric entry screen for the second value.
6. Key in the seconds value and press **ZERO** to accept ...
SEt is displayed.
7. Press **M+** ...
StYLE is displayed. Use this to set the style of clock for printouts. Choices are **12hr**, **12hr-AP** (AM/PM) and **24hr** (military time).
8. Press **SELECT** ...
12hr is displayed.
9. Press **M+** to scroll through the choices. Press **ZERO** to accept the displayed choice ...
StYLE is displayed.
10. Press **CE/C** ...
tiME is displayed.

5.5.2 Date

User ↓ Time → Date

1. From **tiME**, press **M+** ...
dAtE is displayed.
2. Press **SELECT** ...
SEt is displayed.
3. Press **SELECT** ...
y- x is displayed, with the **x** flashing. This is a numeric entry screen for the year value.
4. Key in the year and press **ZERO** to accept ...
M- x is displayed, with the **x** flashing. This is a numeric entry screen for the month.
5. Key in the month value and press **ZERO** to accept ...
d- x is displayed, with the **x** flashing. This is a numeric entry screen for the day value.
6. Key in the day value and press **ZERO** to accept ...
SEt is displayed.

7. Press **M+** ...
StYLE is displayed. Use this to set the style of date for printouts.
 Choices are **MMDD2Y**, **MMDD4Y**, **DDMM2Y** and **DDMM4Y**.
8. Press **SELECT** ...
MMDD2Y is displayed.
9. Press **M+** to scroll through the choices. Press **ZERO** when your choice is displayed ...
 The choice is made and **StYLE** is displayed.
10. Press **CE/C** ...
dAtE is displayed.

5.5.3 Site ID

User ↓ Time → Date → Site ID

1. From **dAtE**, press **M+** ...
Site id is displayed.
2. Press **SELECT** ...
 A numeric entry screen is displayed.
3. Key in a site ID number and press **ZERO** to accept ...
Site id is displayed.



The Site ID can be used in transmitted or printing information. ASCII characters 32-126 can be used.

5.5.4 Seal

User ↓ Time → Date → Site ID → Seal

1. From **Site id**, press **M+** ...
SEAL is displayed.
2. Press **SELECT** ...
unSEAL or **SEALed** is displayed. This is the status of the physical seal inside the indicator. If the unit is sealed, no changes can be made to the configuration of the indicator.
3. Press **F1** to return to the **SEAL** display.
4. To exit the menu, see [Exiting the menus on page 16](#).

5.6 About menu

The About menu is shown in [Figure 5.3](#).

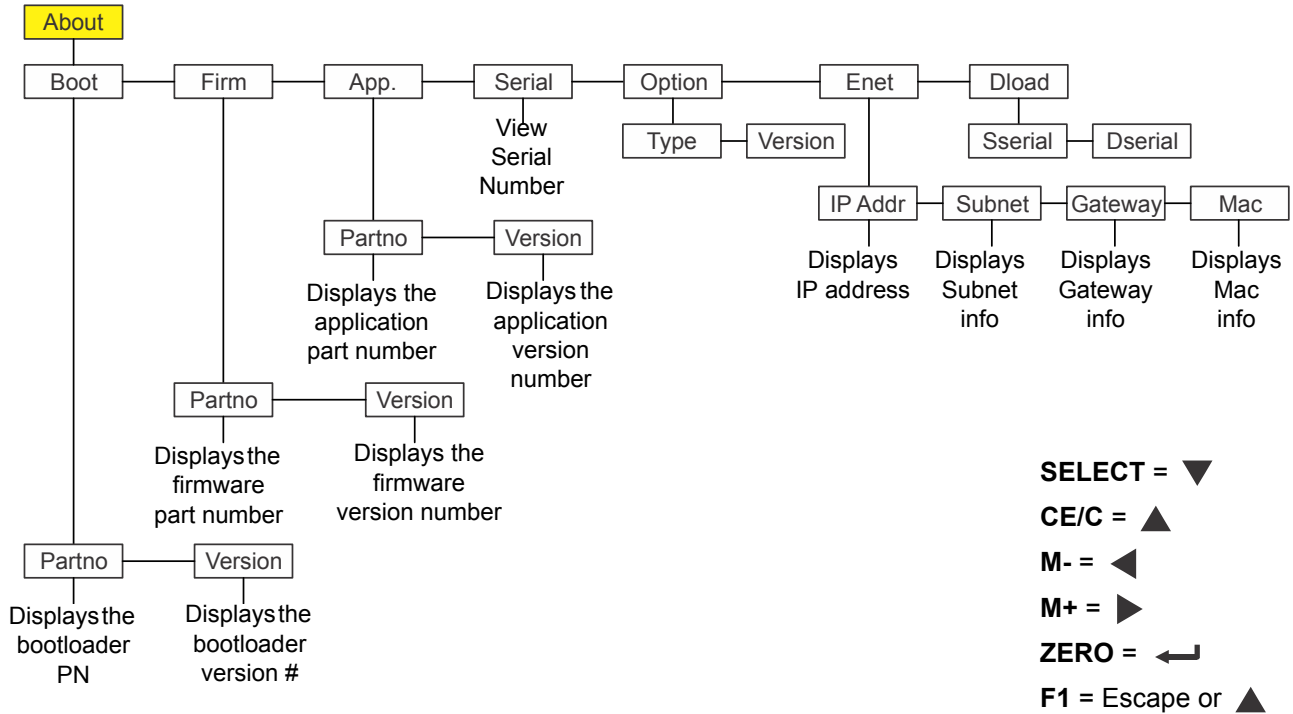

Figure 5.3 About menu

Use this menu to display information about the various items shown in [Figure 5.3](#). Each is explained below. Use the [Numeric entry procedure on page 11](#) when you need to enter values.

5.6.1 Boot

About ↓ Boot

1. Access the About menu and press **SELECT** ...
boot is displayed.
2. Press **SELECT** ...
Partno is displayed
3. Press **SELECT** ...
The 1st half of the bootloader PN is displayed. Press **M+** to view the 2nd half.
4. Press **ZERO** to return to the **Partno** display.
5. Press **M+** ...
VERsion is displayed.

6. Press **SELECT** ...
The version number of the bootloader is displayed.
7. Press **ZERO** to return to the **VERsion** display.
8. Press **CE/C** to return to the **boot** display.

5.6.2 Firm and App

About ↓ Boot → Firm and App

1. From **boot**, press **M+** ...
FirM is displayed. This stands for firmware.
2. Repeat the same pattern of key presses in steps 2 through 7 to view the part number and version for the **FirM**. and **APP** menu items.

5.6.3 Serial

About ↓ Boot → Firm → App → Serial

1. With **APP** displayed, press **M+** ...
SEriAL is displayed.
2. Press **SELECT** ...
The first four digits of the indicator serial number are displayed. Press **M+** to view the last five digits.
3. Press **CE/C** to return to the **SEriAL** display.

5.6.4 Option

About ↓ Boot → Firm → App → Serial → Option

1. From **SEriAL**, press **M+** ...
oPtion is displayed.
2. Press **SELECT** ...
tYPE is displayed. This stands for the type of option card installed. The two option cards are: Profibus and a Relay card.
3. To view the type, press **SELECT** ...
The currently installed option card name is displayed.
4. Press **ZERO** ...
tYPE is displayed.
5. Press **M+** ...
VERsion is displayed. This stands for the software version of the currently installed option card. This can be useful service information.

6. Press **SELECT** ...
The software version number is shown.
7. Press **ZERO** ...
VErSion is displayed.
8. Press **CE/C** ...
oPtion is displayed.

5.6.5 Enet

About ↓ Boot → Firm → App → Serial → Option → Enet



If the indicator is connected to an ethernet network, the values displayed will be the current assigned addresses.

1. From **oPtion**, press **M+** ...
EnEt is displayed. Use this item to view the values for the IP, Subnet, Gateway and MAC addresses.
2. Press **SELECT** ...
iP Addr is displayed. Use this item to view the four part IP address.
3. Press **SELECT** ...
1 XXX is displayed. This is first octet of the IP address
4. Press **ZERO** ...
2 XXX is displayed. This is second octet of the IP address.
5. Press **ZERO** ...
3 XXX is displayed. This is third octet of the IP address.
6. Press **ZERO** ...
4 XXX is displayed. This is fourth octet of the IP address.
7. Press **ZERO** ...
iP Addr is displayed.
8. Press **M+** ...
Subnet is displayed.
9. Repeat this sequence of key presses for the **Subnet**, **Gateway** and **MAC** addresses.
10. When finished press **CE/C** ...
EnEt is displayed.

5.6.6 Dload

About ↓ Boot → Firm → App → Serial → Option → Enet → Dload

1. From **EnEt**, press **M+** ...

dLoAd is displayed. This stands for download. Under **SSEriAL** you can view the serial number of the software application that created the configuration file. Under **dSEriAL** you can view the serial number of the software application that downloaded the configuration file. This is used for security and licensing purposes.
2. Press **SELECT** ...

SSEriAL is displayed.
3. Press **SELECT** ...

The 1st half of the serial number of the creating application of the configuration file is displayed.
4. Press **ZERO** to show the 2nd half.
5. Press **F1** ...

SSEriAL is displayed.
6. Press **M+** ...

dSEriAL is displayed.
7. Press **SELECT** ...

The 1st half of the serial number of the downloading application of the configuration file was downloaded to, is displayed.
8. Press **ZERO** to show the 2nd half.
9. Press **F1** ...

dSEriAL is displayed.
10. Press **CE/C** until **About** is displayed.
11. To exit the menu, see [Exiting the menus on page 16](#).

5.7 Audit menu

The Audit menu is shown in [Figure 5.4](#).

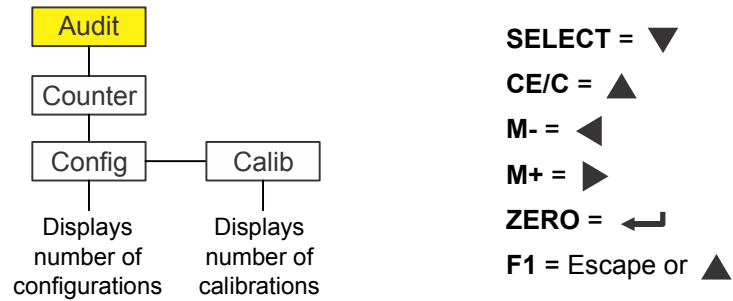

Figure 5.4 Audit menu

Use this menu to display audit counters for configuration and calibration. Each is explained below.

5.7.1 Counter

Audit ↓ Counter

1. Access the Audit menu and press **SELECT** ...
countEr is displayed. This has two counters that tell you how many times the indicator has been configured and calibrated.
2. Press **SELECT** ...
conFig is displayed.
3. Press **SELECT** again ...
A number appears showing how many times the indicator has been configured.
4. Press **ZERO** ...
conFig is displayed.
5. Press **M+** ...
cALib is displayed.
6. Press **SELECT** ...
A number appears showing how many times the indicator has been calibrated.
7. Press **ZERO** ...
cALib is displayed.
8. Press **CE/C** ...
countEr is displayed.

This completes the Audit menu. To exit the menu, see [Exiting the menus on page 16](#).

6 Communications

The ZM205 remote display is connected to the main indicator and powered through the ethernet cable.

If the indicator has the PROFIBUS option, there is no operator involvement required to transmit weight.

If the indicator has the Relay output option, this is tied to setpoint #3 and can be used to activate any number of peripheral devices. The circuit closes under the target weight and is open above the target weight.

7 Supervisor menu

This menu allows a supervisor to change those functions of the application that are configurable. Access the supervisor menu using the password 1793. Refer to [Accessing the menus on page 15](#) for instructions.



Wherever there is an option to print information in the any of the supervisor's menus, the information will print out of Port 1 or Port 2, whichever is chosen.



The menu is explained in a sequential manner to cover all information in a logical fashion. You will probably never access all the menu items in this manner. You can navigate to the area of the menu that needs to be changed by using the navigation key chart shown with the menus.



Use the [Numeric entry procedure on page 11](#) when you need to enter values.

Figure 7.1 shows the Supervisor menu.

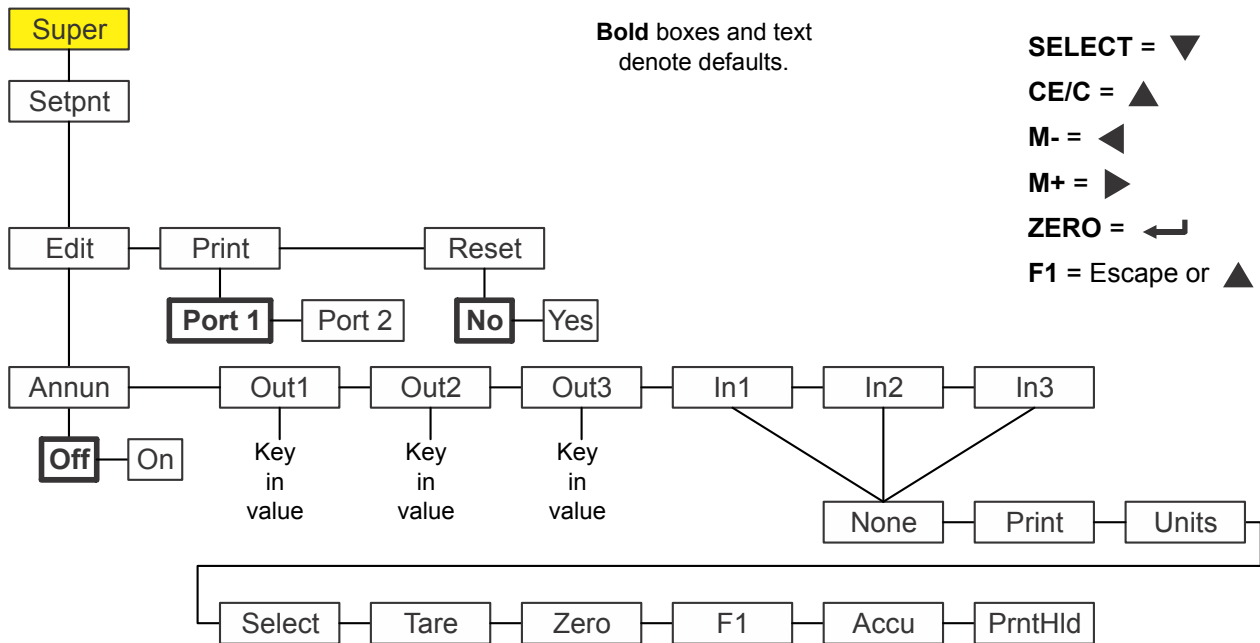

Figure 7.1 Supervisor menu for the General Weighing application

Follow these steps to set the items in the Supervisor menu.

7.1 Setpoint

Super↓ Setpoint



The ↓ and → symbols used in this section stand for direction moved in the menu. So Super ↓ Setpoint, shown above, illustrates that you move down from **SuPEr** to **SEtPnt**. This will help you keep track of where you are in the menu structure.



A setpoint value can be entered up to scale capacity.

Turn off or disable any setpoints you are not using. See the Service manual for information on disabling or turning off setpoints.

1. With the indicator on, access the Supervisor menu. Refer to [Accessing the menus on page 15](#) for instructions. From **SuPEr**, press **SELECT ...**

SEtPnt is displayed. Use this to:

- set the function of the OVER annunciator
- enter up to three setpoint (output) values
- select inputs for up to three inputs
- print the setpoint settings
- reset all setpoint settings to factory defaults.

Annunciators

Setpoint ↓ Edit ↓ Annun

2. Press **SELECT ...**

Edit is displayed.

3. Press **SELECT ...**

Annun is displayed.

This stands for annunciator, referring to the **OVER** annunciator. By default (**oFF**) this annunciator is ON when the displayed weight is below the setpoint value or OFF above the setpoint value. If you select **on**, the annunciator works in the opposite fashion--OFF when below, ON when above.



The **OVER** annunciator is tied to both setpoint 1 and setpoint 3. If the weight exceeds setpoint 1 or 3 the **OVER** annunciator will light.

If the optional Relay output is installed, it is tied to setpoint 3. The circuit will close when the weight is under the target weight and will be open above the target weight.

4. Press **SELECT ...**

The current setting is displayed (**oFF** or **on**).

5. Press **M+** to toggle between the choices and when your choice is displayed, press **ZERO** to accept ...

Annun is displayed.

Outputs

Setpoint ↓ Edit ↓ Annun → Out1

6. Press **M+** ...

out1 is displayed. This is the weight value for setpoint 1.

7. Press **SELECT** ...

The current value is displayed with a flashing right digit.

8. Press **ZERO** to accept the displayed value or key in a new value and press **ZERO** to accept ...

out1 is displayed.

9. Press **M+** ...

out2 is displayed.

10. Repeat steps 7 through 9 for **out2** and **out3**.

Inputs

Setpoint ↓ Edit ↓ Annun → Out(x) → In1

11. Press **M+** when finished ...

in1 is displayed. This stands for input 1. Use this to assign a function to input 1 when an external switch is tripped. Default choice is **none**. The choices are listed in [Figure 7.1](#).



Inputs and Outputs must be enabled ON in a separate password protected menu. Some input choices will not apply in the application that is active.

12. From **in1**, press **SELECT** ...

The current choice is displayed.

13. Press **M+** to scroll through the choices and when your choice is displayed, press **ZERO** to accept ...

in1 is displayed.

14. Press **M+** ...

in2 is displayed.

15. Repeat steps 12 through 14 for **in2** and **in3**. Press **CE/C** when finished ...

Edit is displayed.

Print

Setpoint ↓ Edit → Print

16. Press **M+** ...

Print is displayed. Use this to print the settings under **SEtPnt**.

17. Press **SELECT** ...

Port 1 is displayed.

18. Press **F1** to abort the print process or press **M+** to scroll to the desired port and press **ZERO** to print the information ...

Print is displayed after either action.

Reset

Setpoint ↓ Edit → Print → Reset

Supervisor menu

Avery Weigh-Tronix



Avery Weigh-Tronix USA

1000 Armstrong Dr.

Fairmont MN 56031 USA

Tel:507-238-4461

Fax:507-238-4195

Email: usinfo@awtxglobal.com

www.averyweigh-tronix.com

Avery Weigh-Tronix UK

Foundry Lane,

Smethwick, West Midlands,

England B66 2LP

Tel:+44 (0) 8453 66 77 88

Fax:+44 (0)121 224 8183

Email: info@awtxglobal.com

www.averyweigh-tronix.com